

**NEMTEK**  
GROUP OF COMPANIES



Agri, Equine and  
Game Electric  
Fence Systems

**Instruction Manual**



Introduction & Company Profile _____	3
Warranty _____	4
Nemtek Group Outlets _____	5
1. The Reasons for Using an Electric Fence _____	6
1.1 Why a Monitored Electric Fence?	6
1.2 Electronic Fencing for Game & Poaching Control	6
2. How an Electric Fence Barrier Works _____	8
3. Types of Fences _____	9
3.1 Permanent electric fence	9
3.2 Portable electric fence	10
4. Installing a Permanent Electric Fence _____	11
4.1 Post and wire spacing	12
4.2 Selecting the correct energizer	14
4.3 Solar powered energizers	16
4.4 Earthing the energizer system	20
4.5 Test the earth (ground) system	21
4.6 Lightning and surge protection	23
4.7 High Tension cables, fence wires, rope and tapes	24
Electrical Resistance Charts	24
4.8 Game fencing	26
Permanent installation	26
River crossing	27
Housing the energizer	28
4.9 General information	29
Tensioning of wire	29
Joining wires – line clamps	29
Joining wires – ferrules	29
Gates	30
Cut out switches	30
5. Installation of a Temporary/Portable Electric Fence _____	31
6. Fault Finding _____	32
7. Safety Requirements and Interference _____	34
8. Glossary _____	35
9. Disclaimer _____	37

## **INTRODUCTION**

Thank you for choosing our product! NEMTEK Electric Fence Energizers are designed and manufactured to provide many years of reliable use, if installed and maintained correctly. The guidelines provided in this manual will assist you with the basic operation and maintenance of your energizer.

Currently this energizer is designed and manufactured in South Africa for the South African and international markets. More information on our products and general information are available on our web site at: <http://www.nemtek.com>.

## **COMPANY PROFILE**

The NEMTEK Group of Companies manufacture and distribute intelligent electronic agricultural fencing systems, security and perimeter control systems and have been involved in the security industry since 1990.

We have our own research and development team, designing and manufacturing a full range of globally competitive electric fence energizers and related products.

NEMTEK is continually updating its products according to South African and international standards in order to ensure the highest quality products and continuous customer satisfaction.

**Electric fencing can be lethal. Avoid head contact with the fence. When installing please take careful note of the options available for current limiting resistors, the programmable output energy levels as well as the low-voltage operation of the energizer.**

**WARRANTY**

Unless otherwise specified, all products manufactured and supplied by Nemtek have a two year warranty on energizers and a one year warranty on all other fencing components from date of sale against defects due to faulty workmanship or materials.

Nemtek (Pty) Ltd will, at its discretion, either repair or replace a product that proves to be defective.

Nemtek (Pty) Ltd does not guarantee that the operation of the product will be uninterrupted and totally error free. Faulty units must be returned to one of the Nemtek Group outlets. The buyer shall pay all shipping and other charges for the return of the product to Nemtek (Pty) Ltd.

**LIMITATION OF WARRANTY**

The warranty does not apply to defects resulting from acts of God, modifications made by the buyer or any third party, misuse, neglect, abuse, accident and mishandling.

**EXCLUSIVE REMEDIES**

The remedies provided herein are Nemtek (Pty) Ltd's sole liability and the buyer's sole and exclusive remedies for breach of warranty. Nemtek (Pty) Ltd shall not be liable for any special, incidental, consequential, direct or indirect damages, whether based on contract, tort, or any other legal theory. The foregoing warranty is in lieu of any and all other warranties, whether expressed, implied, or statutory, including but not limited to warranties of merchantability and suitability for a particular purpose.

### **NEMTEK (Head Office)**

Tel: +27 (0)11 462 8283  
Fax: +27 (0)11 462 7132

Stand 251, Aintree Avenue,  
Northriding Commercial Park  
Kya Sand, Randburg, South Africa

### **NEMTEK (Edenvale)**

Tel: +27 (0)11 453 1970  
Fax: +27 (0)11 453 1858

Unit 1 & 2, Meadowdale Office Park  
Cnr. Dick Kemp & Herman Roads  
Meadowdale, Edenvale, South Africa

### **NEMTEK (Cape Town)**

Tel: +27 (0)21 386-3742  
Fax: +27 (0)21 386-5573

27B Concord Crescent, Airport City  
Cape Town, South Africa

### **NEMTEK (Nelspruit)**

Tel: +27 (0)13 752-2187  
Fax: +27 (0)13 752-2188

Waterval Ave, Riverside Industrial  
Nelspruit, South Africa

### **NEMTEK (KwaZulu Natal)**

Tel: +27 (0)31 701-2125  
Fax: +27 (0)31 701-3728

Unit 1, Devon Park, 11 Devon Road  
Pinetown, South Africa

**Website: [www.nemtek.com](http://www.nemtek.com)**

**E-mail: [nemtek@nemtek.com](mailto:nemtek@nemtek.com)**

**Manufactured in South Africa**

### **1. THE REASONS FOR USING AN ELECTRIC FENCE**

A high voltage shock with a physical barrier will deter animals from leaving a controlled environment and venturing out. Wild animal and vermin movement can also be controlled by either keeping them inside a controlled area or outside and separate from another group of animals.

Electric fencing is more affordable than most conventional and traditional barriers in controlling animals. Electric fencing is easily transported. The shock also keeps the animals away from the fence reducing damage to the fence. Portable fences can be erected quickly and smaller areas can be demarcated for grazing rotations.

#### **1.1 WHY A MONITORED ELECTRIC FENCE?**

Monitored or security type energizers can be used in larger permanent fence environments to monitor and indicate the status of an electric fence. These monitored types of energizers will alarm when the fence conditions are not up to an acceptable working standard. These alarms will inform a farmer or game ranger of a break or a short on the fence that requires attention. This would enable the farmer or game ranger to respond timeously and minimize any damage or harm to livestock or game.

#### **1.2 ELECTRIC FENCING FOR GAME & POACHING CONTROL**

Most animals whether domestic, farm or wild will remember the shock of an electric fence and this creates a psychological barrier for the animal. The animal's initial interaction with an electric fence must be memorable in order to get the animal to respect the barriers set by the fence. Wild animals in general would not be familiar with electric fences, also because of large expanses many rarely come into contact with the fence or find themselves colliding with the fence in the dark. It is advisable where possible to introduce the animals to electric fences in smaller enclosures before releasing them into the wild. Electric fencing in these enclosures must work very well so that the animals grow to respect the shock from the fence.

The cost of many long game fences can be prohibitive and electric fencing is one of the most cost effective solutions.

With long fences it can be challenging to locate a fault on the fence when large sections of fence need to be covered. By cleverly designing the fence, introducing cut-out switches and fence lights along the fence line, the time taken to locate faults is reduced.

# NEMTEK

Although larger energizers can power long fences, poaching has introduced a new challenge. Smaller sections of the fence can be monitored with more energizers being installed along the fence and this helps reduce the alarm zone lengths. This ensures that any breaks on the fence or breach of fence security can be timeously addressed with minimal harm to the animal and the fence. An energizer that also monitors the fence line and alarms when there is a fault on the fence or when the fence is tampered with will assist with the fight against poachers and unwanted intruders.

Earth conditions along the fence change with the season and the effectiveness of the fence-earthing is important in delivering the shock to the animal. Keeping the fence clean and operational will result in an effective electric fencing system.

Voltage on a fence is very important and is what delivers the energy (joule) to the point on the fence where the shock is required. The problem with high voltage is that it can create arcing and energy losses if the fence is not installed to standard or if there is vegetation or other voltage and energy parasites along the fence line which affects the fence's efficiency. To help overcome this intelligent energizers have been introduced into the Nemtek range. These energizers detect how much power a fence can accept and handle before it starts to arc and waste energy. This allows the fence to operate at higher voltages. Nemtek's rule of thumb is that the voltage must be no less than 6500 Volts anywhere along the fence line. These energizers actively analyze the fence and adapt the transfer of power as needed to ensure that the fence operates at maximum performance.

### 2. HOW AN ELECTRIC FENCE BARRIER WORKS

An electric pulse (current) will travel from the energizer through the live (hot) wires. The current flows through the animal at its contact point on the fence. The current then travels into the ground and will seek a return path via the earth spikes back to the energizer. This completes the electrical circuit and the animal is shocked. The circuit is completed almost instantaneously.

The shock creates an unpleasant memory and thus a psychological barrier that most animals recall very quickly and for a long period of time. Different animals require different levels of shock or energy, the level is not based only on the size of the animal but also on the temper and type of animal. Once the animal has been shocked chances are that it has learnt its lesson and it will avoid the fence.

An electric fence does not have to be very robust but it must rather be visible to the animal so that the animal can see it to avoid it.

Fig. 2.1

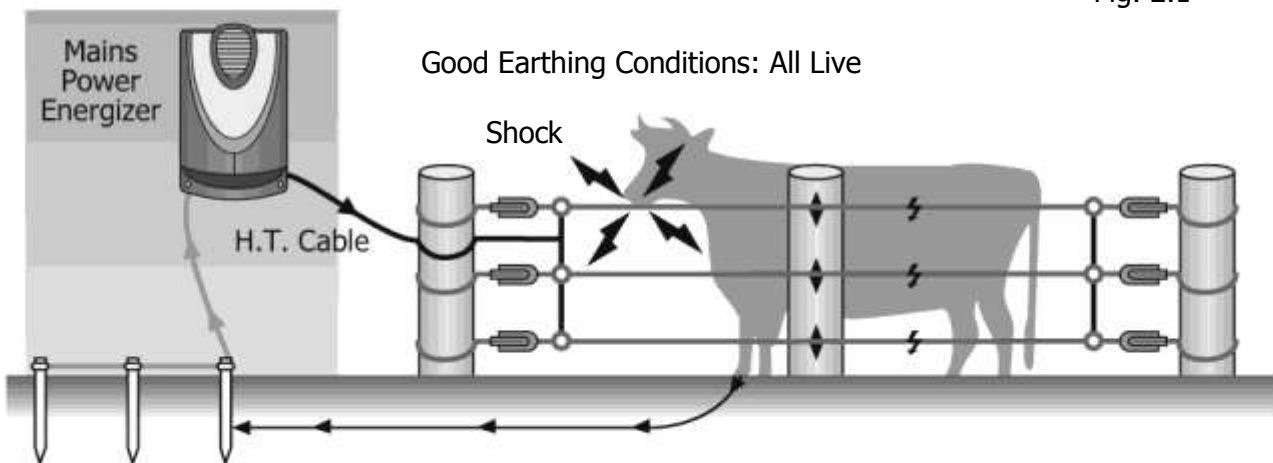
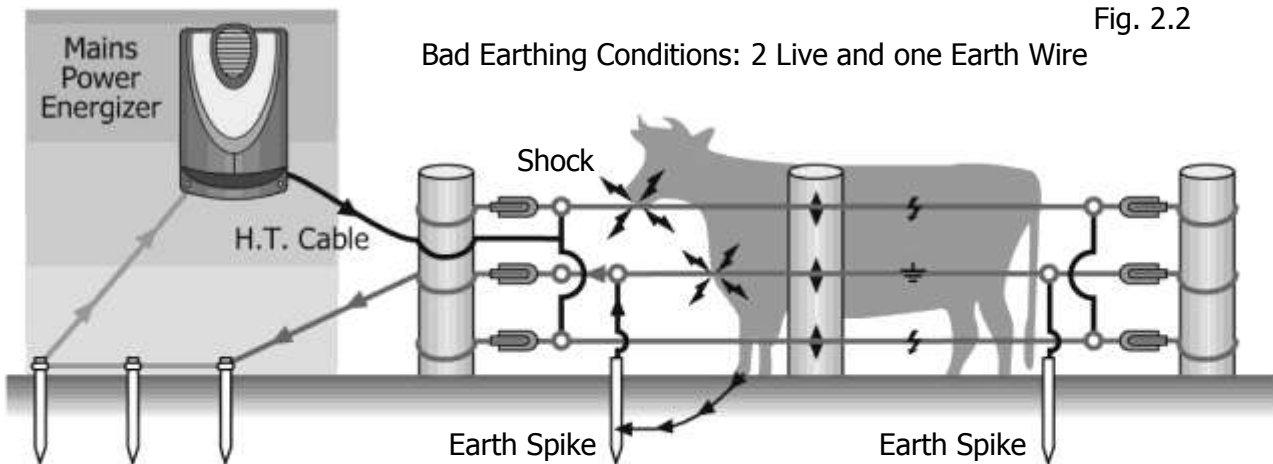

Fig. 2.2





## 3. TYPES OF FENCES

### 3.1 Permanent electric fence

Electric fences can be either permanent or temporary.

A permanent fence for game animals or livestock will require higher tensile strengths, be more robust, have a longer life span and use more durable insulators and equipment.

Animals tend to run into the fence before seeing it and there is a high likelihood they could damage the fence especially in the dark.

- |                             |                         |
|-----------------------------|-------------------------|
| 1. Electric fence energizer | 7. Fence wire           |
| 2. High Tension (HT) cable  | 8. Strain insulators    |
| 3. Earth spikes             | 9. Wire tensioners      |
| 4. Earth cable              | 10. Line clamps         |
| 5. Intermediate posts       | 11. Cut-out switches    |
| 6. Tension posts            | 12. Nemtek warning sign |

Fig. 3.1

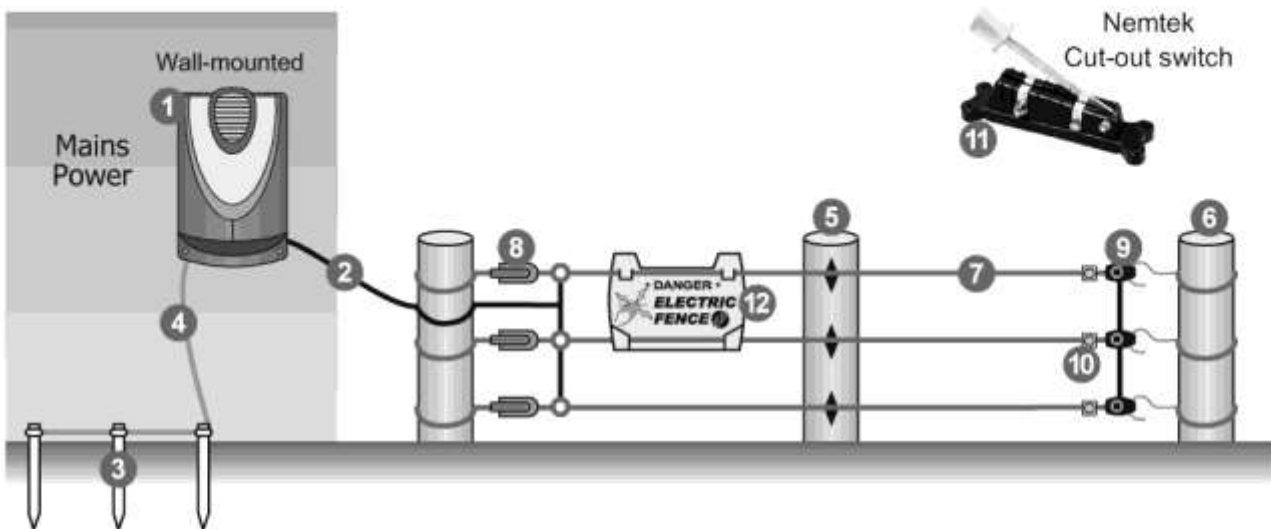

## 3.2 Portable electric fence

Portable fencing can be moved as required creating temporary paddock, strip-grazing areas, or even to protect flower beds and refuse areas from pets or feral animals.

The energizers are generally smaller units that can run for many days on battery power, or can be powered with solar cells and a battery back-up.

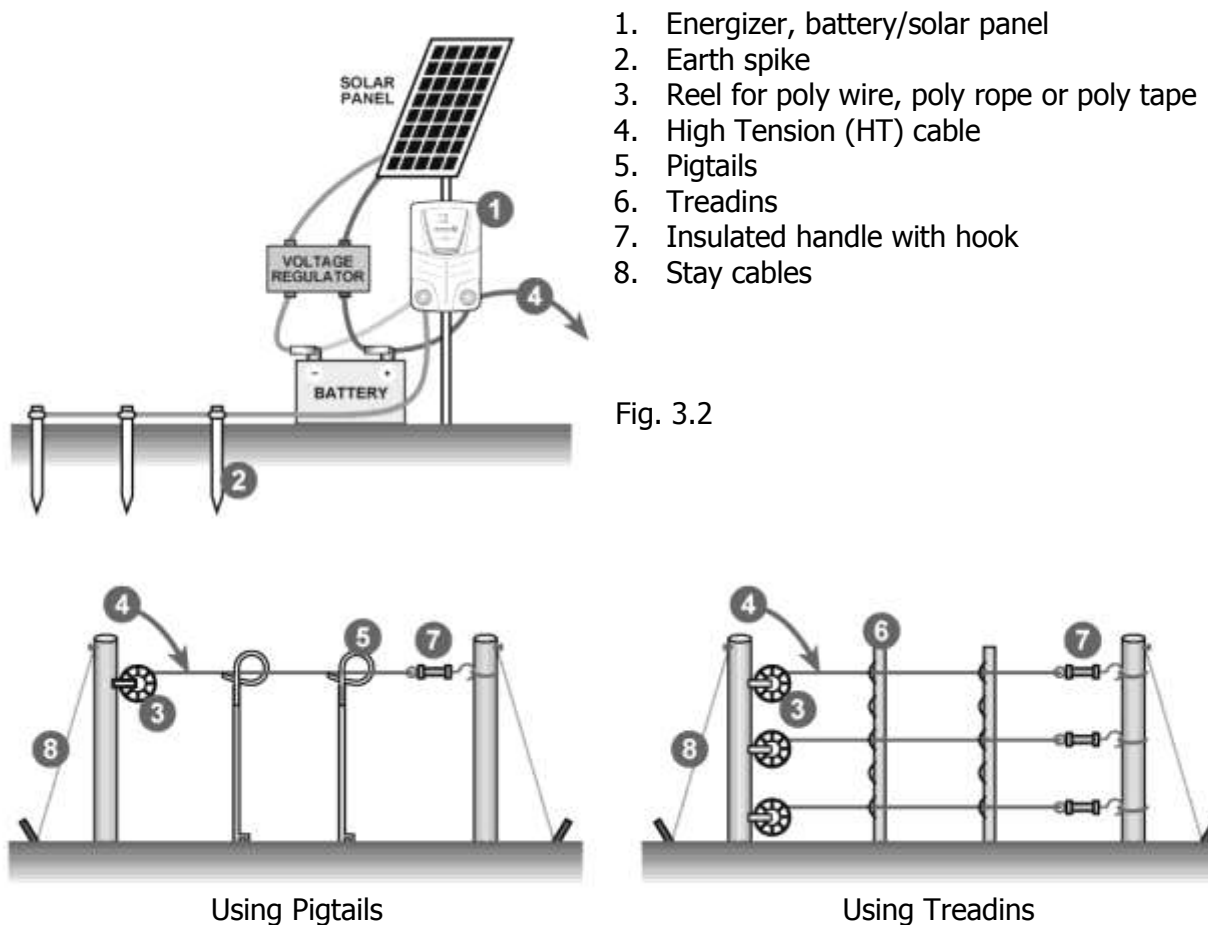

See section 5 on page 31 for more details.

## 4. INSTALLING A PERMANENT ELECTRIC FENCE

It helps to plan your fence layout taking various needs into account, which include:

- Energizer location and power source
- Water supply and feeding stations
- Gate and access points
- Terrain levels, trees, obstacles
- Corners and termination points
- Temporary fences within permanent system
- Roadway between the different paddocks

Note 1: A Cut-out Switch is used to isolate areas of the fence for quick and easy fault finding.

Note 2: The feeder cable should be kept away from communication lines, specially if it runs parallel for long distances. Where the feeder High Tension cable crosses over it should be done at right angles to the communication cable.

Figure 4.0 - Ideal fence layout

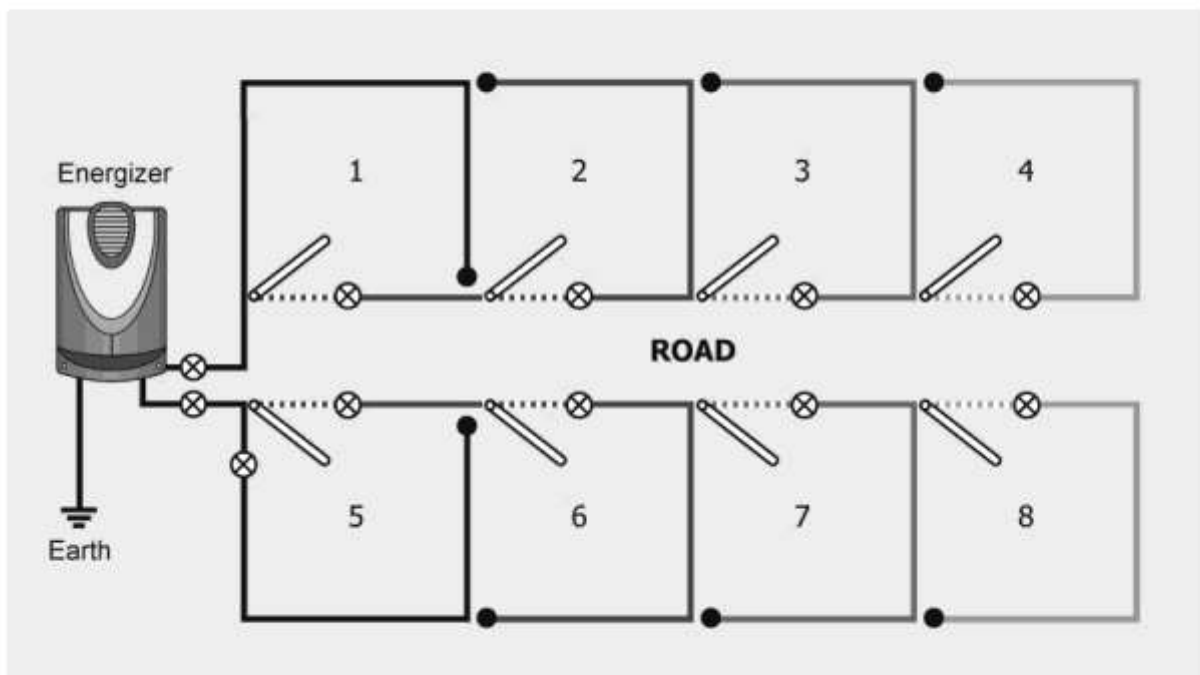
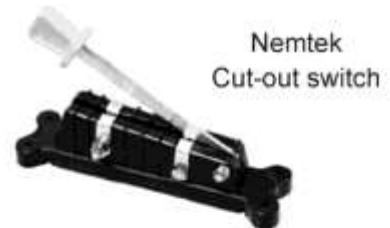
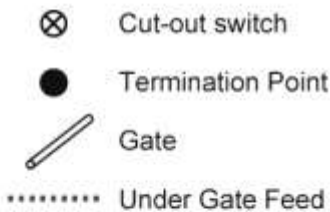

# NEMTEK

## 4.1 Post and wire spacing

These are guidelines only, spacing between the wires and the posts can vary depending on the terrain and the changing needs.

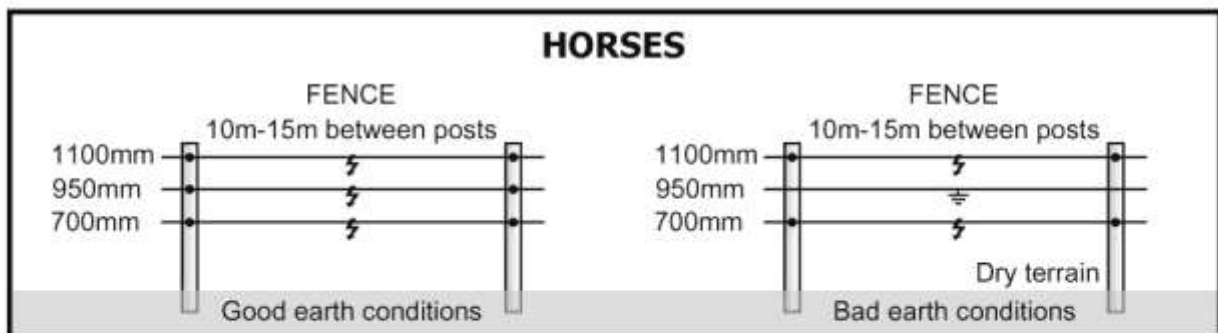
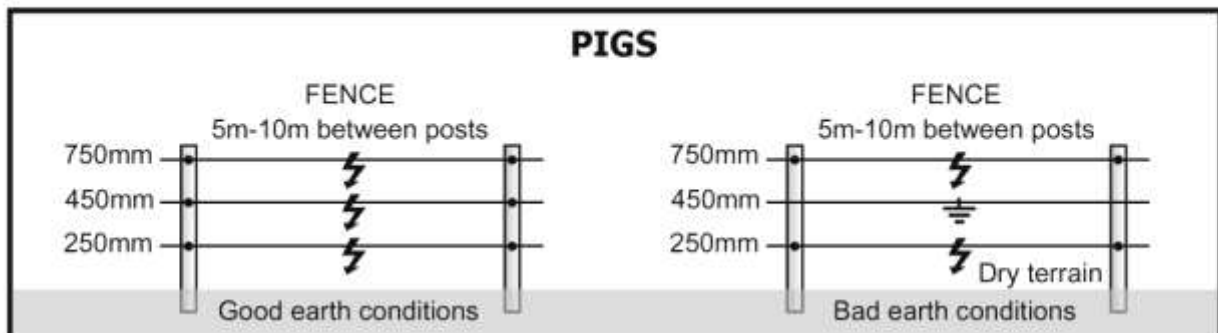
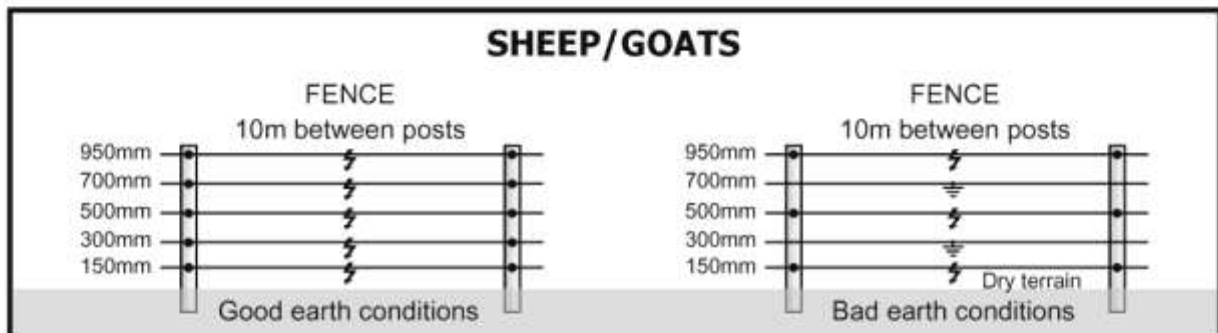
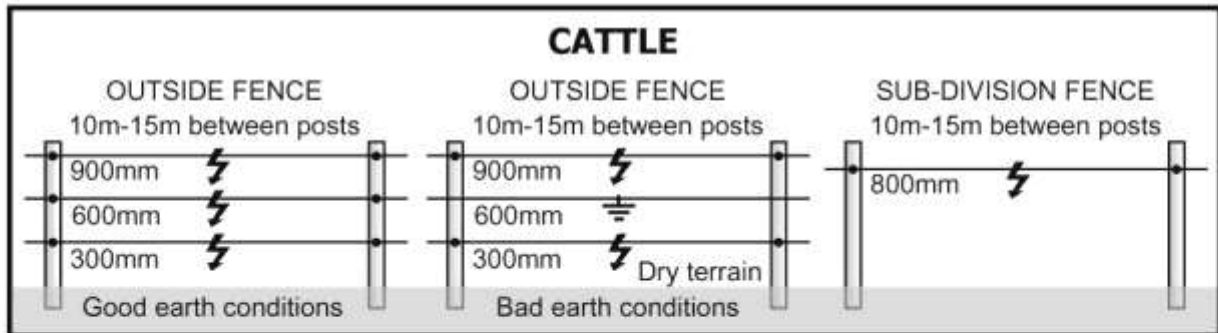

indicates a live wire



indicates an earth (ground) wire

# NEMTEK

## BUCK

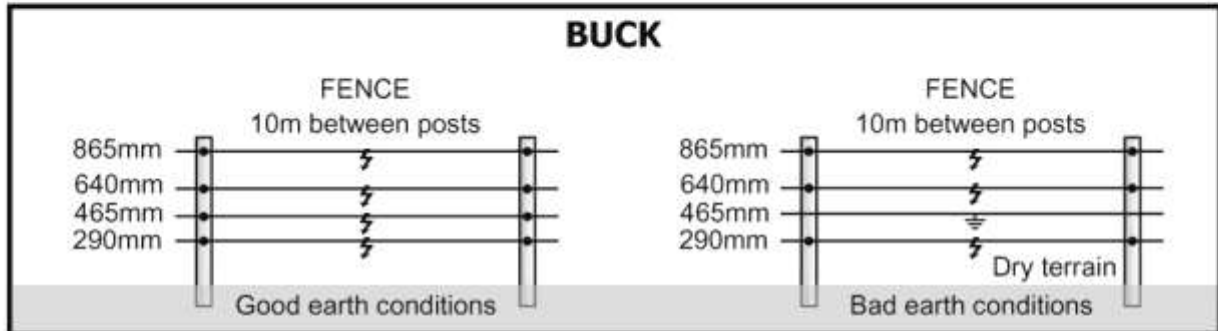

## RABBITS

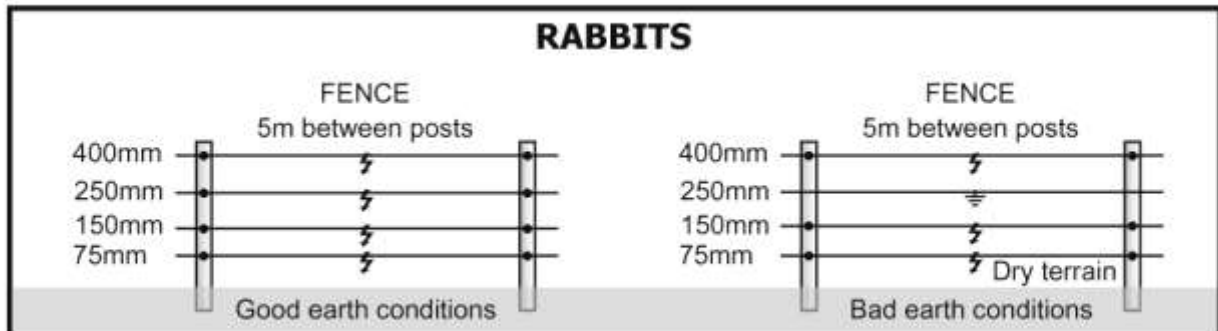

## FERAL

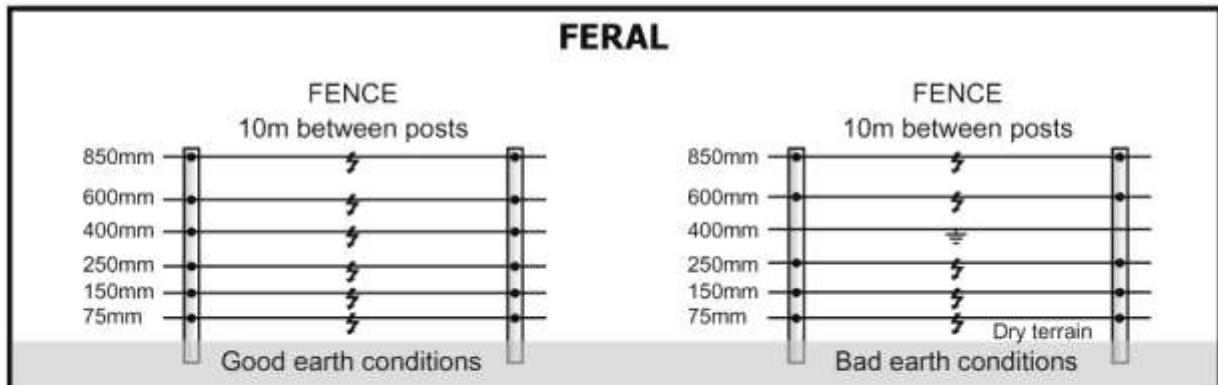

NOTE: Construction of a feral fence will vary depending on the types of animals.  
The diagram above shows a general fence layout for feral animals.

## 4.2 Selecting the correct energizer

Nemtek energizers incorporate our advanced and patented Adaptive Power Technology referred to as APT. What this means is that the fence voltage is maintained at a higher level than would normally be achievable using a conventional energizer on the same fence under varying conditions. Factors such as poor or damaged insulators after a rain storm, or salt build up on insulators (at the coast) prevent the fence from supporting a high voltage. A conventional energizer will push all available energy through any arcing that may occur across the insulator affecting the energy thus reducing the effectiveness of the fence. Nemtek energizers, incorporating APT, will detect the arcing and attempt to operate the fence at a voltage just below that at which arcing occurs. The energizer consistently attempts to drive the fence at the highest voltage the fence can sustain. For example, as a wet fence dries out, the energizer will automatically raise the voltage on the fence thus maintaining higher energy levels on the fence and improving the effectiveness of the fence.

The energizer and fence are equally important. You will not have an effective installation if the energizer is unable to energize the fence, or if your fence is unable to sustain a good voltage and energy level from the energizer.

- Energy delivered by an energizer is measured in joules, with the abbreviation J.
- Nemtek energizers are classified by their output energy and not their stored energy.
- Output energy is the true available energy at the terminals from the energizer, into a specified load.
- Stored energy on the other hand may be used as an indication of energizer potential, but does not factor in losses within the energizer. As no energizer is 100% efficient, no energizer is able to deliver all of the stored energy to the terminals of the energizer.

When choosing an energizer, one has to consider the type of fence the energizer is going to be connected to. Series connected fences require energizers capable of delivering higher voltage, but do not necessarily require high energy. As the voltage drops along the fence, the higher starting voltage ensures a more effective, higher voltage at the end of the fence. Large games fences with many parallel strands of large diameter wire need low impedance energizers capable of delivering sufficient energy. Output voltage is still important though, and needs to be sufficiently high to jump the gap between the animal's skin and the fence. This gap is present due to the animals insulating coat, more so with thick coated animals such as sheep.

Mains powered energizers are viable where you have reliable mains power. Mains powered energizers, with internal battery backup, provide peace of mind should you experience an occasional power outage. Solar powered battery energizers are required in remote areas with no mains power. See the section on solar installations on pages 16 to 19.

Portable battery powered energizers are generally operated by a 12 volt rechargeable Battery.

There is a Nemtek energizer suitable for any situation.

# NEMTEK

Generally, you can determine the energizer required by the length of the fence run.

Nemtek has tailor-made an innovative, cost effective product range specifically to meet the needs of the domestic farming and game farming communities. Durability, reliability, effectiveness and value for money are paramount in every product that bears the Nemtek name.

## Placement of energizers

- Energizers should be installed in a position that makes the information output easily readable.
- The energiser must not be placed on the ground where it can get damaged by the elements or wildlife. Place the energizer on a pole or wall, preferably at a height that makes the information easier to read.

---

## Energizer selection chart

<b>Energizer</b>	<b>Energy Output</b>	<b>Portable/Permanent</b>	<b>Battery/Mains</b>
Agri 1/2J	0.5 Joule	Portable	Battery or Solar
Agri 1J	1 Joule	Portable	Battery or Solar
Agri 2J	2 Joules	Portable	Battery or Solar
Equi 2J	2 Joules	Portable	Battery or Solar
Druid LCD 114A	13.8 Joules	Permanent	Mains

---

Fig. 4.3

## 4.3 Solar powered energizers

### Why Solar Power

It is mainly for economic reasons that a solar power system is used as the supply for Nemtek's electric fence energizers. A solar system can be a reliable and cost effective supply in places where there is no mains supply or the mains supply is unreliable. Solar power is also a clean and renewable energy source and if there are concerns about the carbon footprint solar power will be a viable solution.

### The Solar Power System

In a solar power system you will typically find:

- Solar Panel(s)
- Regulator
- Deep Cycle Battery
- Load
- Cabling

### The Solar Panel

The solar panel converts sunlight into electricity. It is built with a number of solar cells. Each cell will generate about 0.5 Volts. A number of cells are wired in series to increase the output voltage of the panel and a group of 36 cells will be sufficient to charge a 12V battery. By paralleling cells or groups of cells the output power of the panel can be increased. Solar panels can also be wired in series or parallel to increase the output voltage or power of the system.

### The Regulator

The regulator is required in the system to control the output voltage from the solar panels. It prevents the solar panels from overcharging the battery and it will supply the correct voltage to the load. The regulator also protects the battery from being over discharged by disconnecting the load when the battery voltage becomes too low. The life span of the battery will be extended in this way.

Fig. 4.3a

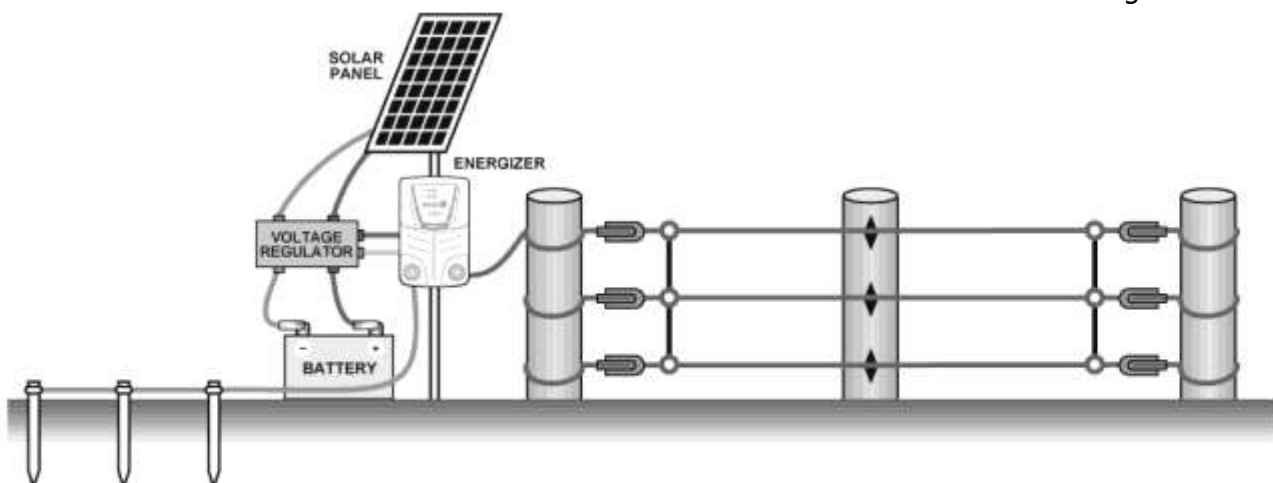



# NEMTEK

## **The Deep Cycle Battery**

Batteries are required in a solar power system in order to store the energy received from the solar panels and supply the load for the periods when there is no, or not enough sun available to power the system. Since the batteries will go through a charge and discharge cycle every day, not every type of battery is suitable in a solar power system. Car batteries for example are not suitable for the system. A Deep Cycle battery is required as they are specially designed to handle the cycles and if rated correctly they will be able to supply the system for many years.

## **The Load**

The load is the equipment that has to do the work. This can be a Nemtek Electric Fence energizer, a gate motor, a pump or maybe just a light. What is important to know about the load is the voltage it operates on, what current it draws and how long it must operate for. All this information is required before a solar power system can be designed.

## **Cabling**

Electric cables are used to connect the panels to the regulator and the regulator to the battery and the load. The cables must be rated correctly not only to prevent overheating of the cables but also to ensure low loss of energy.

If all the components in the system (panels, battery, regulator and load) are close together then the cable lengths will be short. This means the voltage drop across the cables will be low which will make the system more efficient and the load will be able to operate for a longer period from the battery.

## **Location and orientation of the solar panel**

The location of the solar panel must be such that no shadows fall on the panel during peak sunlight hours (9am – 4pm). Solar panels should always face in the direction of the equator, in the southern hemisphere it should face true North and in the northern hemisphere true South. The best angle of inclination or tilt of the panel depends on the time of the year as well as the latitude where the panel is situated. If the panel is a fixed panel and the tilt cannot be changed then it should be set optimally for the winter position since the energy from the sun will be the lowest during that season. If it works in winter it should work in the other seasons. If the frame for the panel is adjustable then the following tilts from the horizontal can be used.

- **Winter - latitude + 15°**
- **Spring - latitude – 2.5°**
- **Summer - latitude – 15°**
- **Autumn - latitude – 2.5°**

For the southern hemisphere the adjustment dates would be April 14, August 27, October 20 and February 22. For the northern hemisphere the dates have to be adjusted by 6 months.

# NEMTEK

## **Load calculation**

The first step in sizing a solar power system is to establish how much power is required by the load and for how long the load is switched on. The operating time of the load varies by application. An electric fence normally has to operate 24 hours a day. A gate motor might only operate for 20 minutes in a day. The power requirement of the load is normally stated by the manufacturer of the equipment, but one has to be careful when reading the manufacturer's label for example a 220V AC mains supplied electric fence energizer which can also work on battery has a rating of 40W but almost half of that power is used to charge the battery of the energizer. The 12V DC rating of that energizer is more likely to be 20W. If you are not sure check the DC rating with the supplier of the equipment.

If you take as an example a 20W 12V Nemtek Electric Fence Energizer together with a 12V 15A gate motor. The load current for the energizer is  $20W/12V = 1.66$  Amps. If this is to be supplied for 24 hours the load requirement will be  $1.66 \times 24 = 40$  AH/day. The gate motor requires 15 A for 20 minutes a day so the requirement will be  $1/3 \times 15 = 5$  AH/day. The total load requirement will be  $40 + 5 = 45$  AH/day. You should however allow for 20% losses in the system so this will give  $45 \times 1.2 = 54$  AH/day.

## **Solar Input calculation**

The amount of solar radiation is location dependent. Johannesburg is rated at 5.5 hours full sun hours a day and Cape Town at about 4 hours. Maps are available on the internet for solar insolation for every area in the world. If the example above was situated in Johannesburg the solar panel must be rated for a maximum power current of  $54/5.5 = 9.8$  Amps.

## **Selection of the solar panel**

If you multiply the maximum power current of the panel with the maximum power voltage you will get the power requirement of the panel in watts. A solar panel for a 12V system has a maximum power voltage of about 17.5 volts. The solar panel rating should be  $9.8 \times 17.5 = 171.5$  W It is always best to go bigger if possible so select 2 x 100W panels.

## **Selection of the regulator**

Most regulators control the output of the solar panel by shorting the panel for short periods, so you should use the short circuit current of the panel to calculate the rating of the regulator. The rated short circuit current of a 100W panel is 6 Amps so for two panels this will give a total of 12A. It is best to select a regulator with a 25% margin so that is more than capable of handling the total short circuit current ( $12 \times 1.25 = 15$  A). Select a 15 Amp regulator for this example.

## **Selecting the battery**

To achieve a reasonable life span from the battery you should not discharge the battery more than 20-25% on a daily basis. This will give you a 3-4 day standby period for the system during bad weather conditions. The battery could discharge 45 AH/day so the capacity of the battery should  $45 \times 4 = 180$ AH.

# NEMTEK

## Wiring and Cabling

The standard wiring (fig 4.3b) is relatively simple. The solar panel(s) must be wired to the solar panel input of the regulator. The battery connects to the battery output of the regulator and the load connects to the load output of the regulator. Attention has to be paid to the polarities since all equipment is polarity sensitive and damage can occur if positive and negative connections are swapped around. Sometimes it is necessary to connect the load directly across the battery (fig 4.3c). For example if the load draws a heavy current for only a short period. A Battery fuse is then recommended in case of a load failure or over current. The current rating of all the wires in the standard system should be at least 1.5 x the short circuit current of the solar panel array. If the load is connected across the battery then the load cables should be rated for at least 1.5 x the peak current of the load.

One of the problems with a 12V solar panel system is the voltage drop across the interconnecting cables. A drop of not more than 2% is recommended. This is only 0.24V or 240mV in a 12V system, otherwise the losses in the cables will make the system inefficient and standby periods will be reduced. To achieve low losses you should try to keep panels, battery, regulator and load as close as possible together to reduce cable lengths.

For a 20W energizer: If the cable length is 8 metres, the current rating for the energizer is 1.66 Amp and the volt drop allowed is 240mV ( $240/1.66/8 = 18 \text{ mV/A/m}$ ). A 2.5mm<sup>2</sup> wire can be used since it has a volt drop of 17mV/A/m which is lower than the 18 mV/A/m calculated. The wire is rated at 20A which is more than 1.5 x 12 (short circuit current of the solar panel) = 18 A. It is very important to keep all the components of the solar system as close together as possible otherwise wire sizes become large and it will not be easy to fit large wires into the connectors on regulators or loads.

Fig 4.3b: Standard wiring diagram

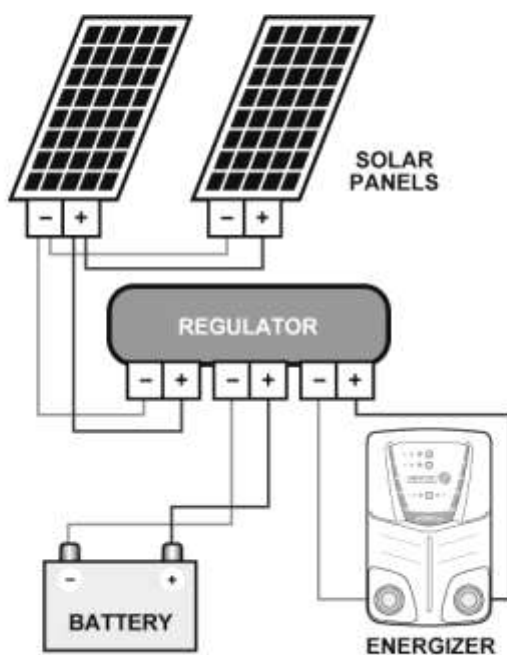
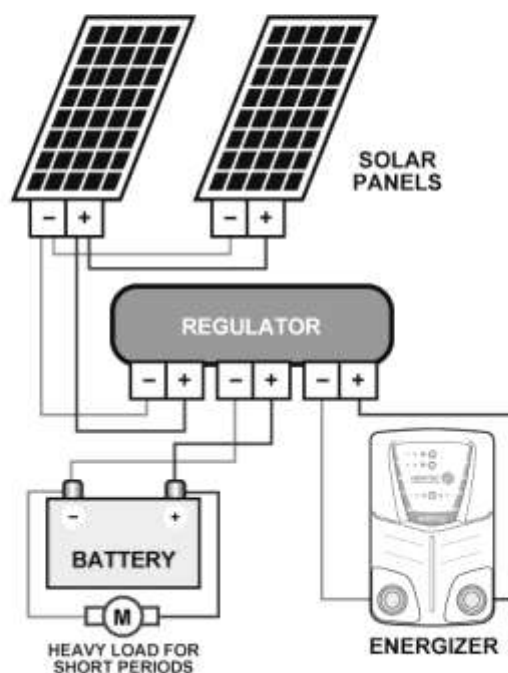

Fig 4.3c: Wiring diagram – load across battery



## 4.4 Earthing the energizer system (ground system)

An electric current requires a source path and a return path. In an electric fence, the source paths are the live wires of the fence, and the return path is the earth (sand/ground) as well as any earth wires on the fence.

The number of earth spikes will vary depending on the power of the energizer and soil conditions. High powered energizers need more spikes than low powered energizers, and dry soils conditions require more spikes than wet soil conditions. Damp is most effective for earthing.

Fig 4.5

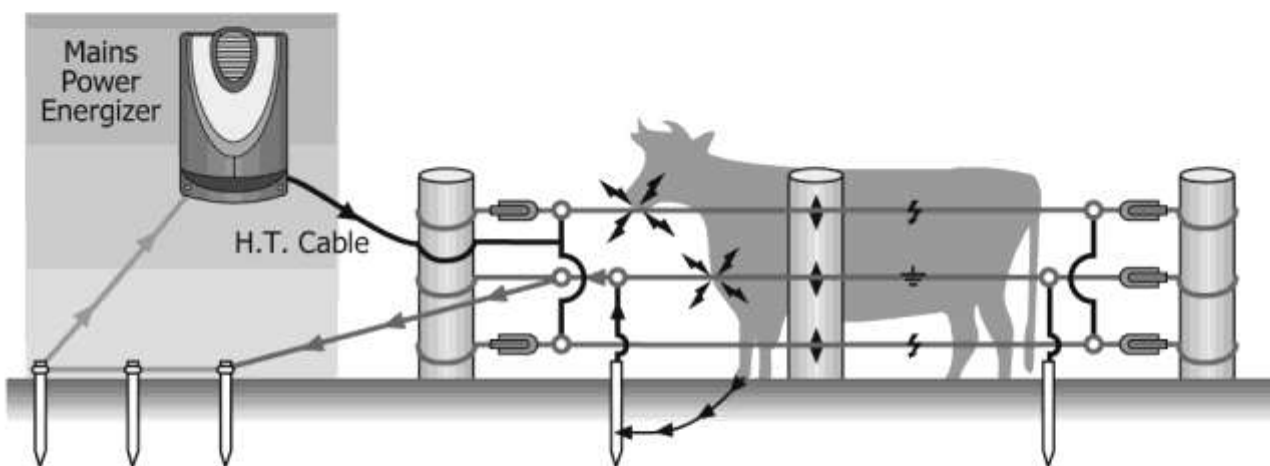

Place three earth spikes at the beginning of the fence and thereafter as required. The High Tension cable must first go to the earth spikes before you connect it onto the earth wire on the fence. This will assist in reducing surge damage in high lightning areas.

The earth spikes must be placed at least 2m apart. If they are too close this reduces the earthing.

The earth of the fence must be at least 10m away from electrical earths and telephone earths. It is recommended that it is placed even further from water carrying pipes and sheds made of steel.

## 4.5 Test the earth (ground) system

To ensure you have an adequate earth system, perform the following procedure and measurements;

At least 100m (330ft) down the fence, away from the energizer earth spikes, drive an earth spike into the ground and short this spike to the fence live wires. Add additional earth spikes until the fence voltage at this point is reduced to 2000V (2kV) or less. Using a Nemtek FenceScope (set to PROBE function) measure the voltage between the energizer earth spikes and an independent test earth spike driven into the ground one meter away.

This test earth spike should be at least 800mm long. (see Figure 4.6a).

The reading, if any, on the FenceScope, should be below 300V.

If the measured voltage is greater, switch off the energizer and drive in additional earth spikes at the recommended spacing, and connect them to the existing earth system. Repeat this process until the measured voltage is reduced to an acceptable level.

### Main causes of a poor earth are:

- Rusty or corroded earth spikes
- Broken earth wire connecting the spikes
- Not enough earth spikes
- Spikes too close together or too short
- Poor connections at the spikes or in the connecting wire

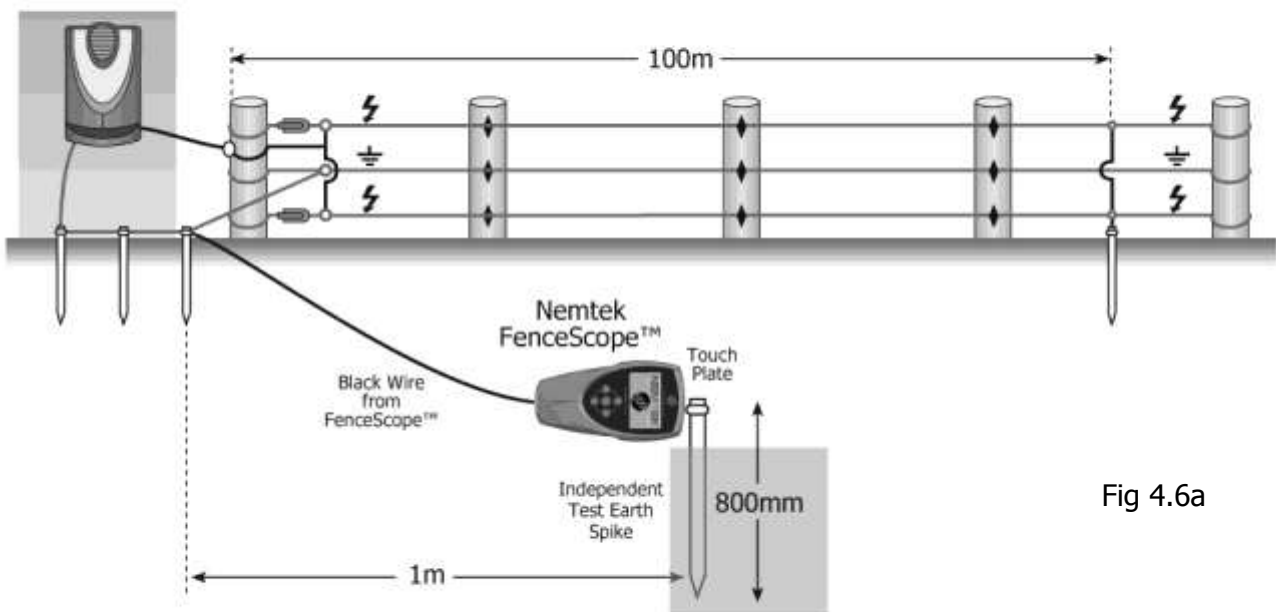

Fig 4.6a

## Testing an earth (ground) return wire and fence live (source) wire

Take a Nemtek FenceScope (set to ENERGY function) and measure (using the red and black leads) the voltage and energy between the live and earth wires at the end of the fence. Fig 4.6b.

The voltage reading should be greater than 3kV for the fence to be effective. The energy reading should be greater than 0.4J for larger animals, and 0.2J for smaller animals.

Note the FenceScope includes an internal 1000 ohm load between the red and black wires.

If you suspect the energizer is unable to drive your fence; remove the FenceScope and replace it with the external 1000 ohm load resistor supplied along with the FenceScope. Go back to the energizer and with the FenceScope (set to PROBE mode) connect the black lead to the energizer earth terminal and the FenceScope touch plate to the energizer live terminal and measure if the voltage is significantly greater than the voltage you measured at the end of the fence. If it is, then the energizer is not the problem and further investigation into the fence wiring needs to be conducted as follows.

Install a standard length earth spike at the end of the fence.

With the external 1000 ohm load resistor still in place between the fence earth and live wires (see Fig 4.6c) and using the FenceScope (set to PROBE mode) connect the black lead to the end of fence earth spike and the FenceScope touch plate to the fence earth wire, the same earth wire the external load is connected to. If the measured voltage is greater than 1000V (1kV) check the earth return wire for bad connections. If the earth return wire is satisfactory, check the integrity of the fence live wire connections.

Finally connect the independent end of fence earth spike to the earth return wire as a permanent connection.

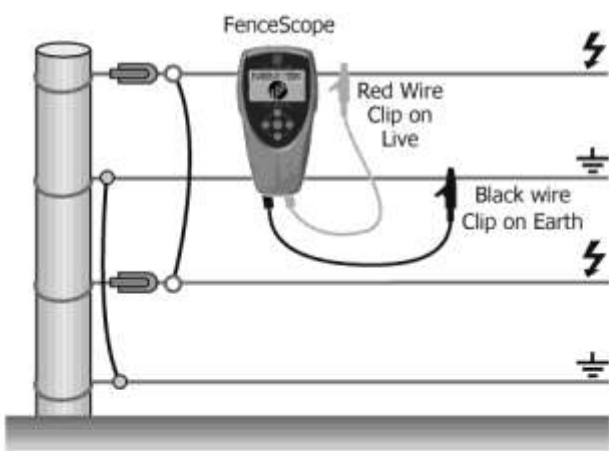

Fig 4.6b

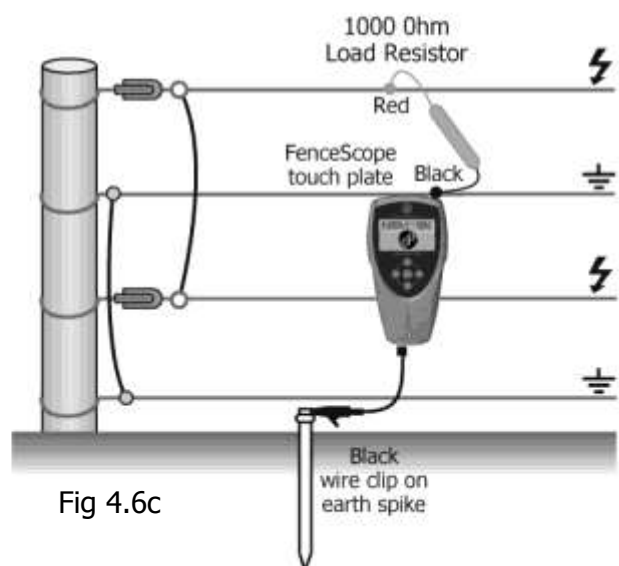

Fig 4.6c

## 4.6 Lightning and surge protection

Surge caused by lightning can damage the energizer, especially an energizer that relies on mains supply as the surge can come from the mains system.

A lightning diverter can assist in reducing damage that comes from the fence. The surge will first be introduced to the diverter which should dissipate most of the surge to ground before it enters the energizer.

An H.T. cable coil resists the surge passing through and helps direct the surge through the lightning/surge diverter

To increase protection use more than three earth spikes. Four to five earth spikes will assist in the surge dissipation into the ground.

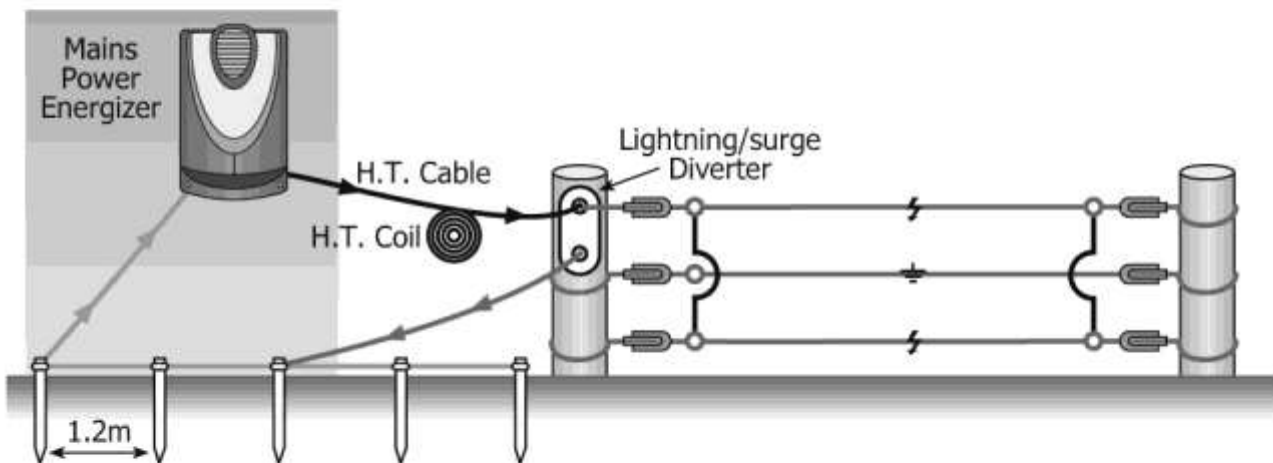

## 4.7 High Tension cables, fence wires, rope and tapes

### High Tension (HT) cable

High Tension cables are used to carry the high voltage from the energizer to the fence. They are insulated to avoid shorting to the earth system.

For longer runs use a lower resistant High Tension cable. The lower the resistance (Ohms) the less the power loss.

#### HIGH TENSION CABLES: Electrical Resistance Chart

Wire/Cable	Resistance (Ohms/Km)	Application
2.5mm Long Life High Tension Cable	36	For permanent Agri and Game Fencing Used for long runs to minimise loss of power
1.6mm Long Life High Tension Cable	98	For permanent Agri and Game Fencing Used for shorter runs with thinner fence wire
1.1 Under Gate Flexible High Tension Cable	45	Ideal for temporary fencing where Poly Wire Poly Tape or Poly Rope has been used
1.6 Aluminium High Tension Cable	27	For permanent and temporary Agri fencing when using low resistance aluminium wires

### Fence wires

There are many types of wires for fencing systems, offering different features and benefits. Resistance, life-span depending on the environment and strength are factors that need to be considered

#### FENCE WIRES: Electrical Resistance Chart

Wire/Cable	Resistance (Ohms/Km)	Application
Stranded galvanised wire – 1.2mm	175	Inland – Dry/good conditions +50km from coast
Stranded galvanised wire – 1.6mm	100	Inland – Dry/good conditions +50km from coast
Stranded galvanised wire – 2.0mm	60	Inland – Dry/good conditions +50km from coast
Light galv high strain wire – 2.24mm	50	Inland – Dry/good conditions +50km from coast
Heavy galv high strain wire – 2.24mm	50	Marine 500m-3km from coast
Solid stainless steel wire – 1.0mm	1000	Coastal – inland +5-25km from coast
Solid stainless steel wire – 1.2mm	700	Coastal – inland +5-25km from coast
Stranded stainless steel wire – 1.2mm	700	Coastal – inland +5-25km from coast
Solid stainless steel wire – 1.0mm	1000	Coastal, 0-500m from coast
Solid stainless steel wire – 1.2mm	700	Coastal, 0-500m from coast
Solid stainless steel wire – 1.6mm	390	Coastal, 0-500m from coast
Solid stainless steel wire – 2.0mm	250	Coastal, 0-500m from coast
Stranded stainless steel wire – 1.2mm	700	Coastal, 0-500m from coast
Aluminium Alloy 1.6mm solid	27	Coastal, 0-500m from coast
Aluminium Alloy 2.0mm solid	14	Coastal, 0-500m from coast



## Poly wires, rope and tapes

Poly wires and ropes are used for temporary enclosures where the electrical fence system will be moved periodically.

Poly tapes are mainly used with horses due to the high visibility they offer the animal.

All Poly products are made to increase the visibility of the fence. High conductivity is important as it reduces the loss and increases the detaining factor.

The mix range offers stainless steel threads, which are durable, mixed with high conductive strands to decrease the resistance.

Animal vision is better than human vision with regards to blues, violets and ultra-violets, thus the choices of colours being mainly blues.

---

### **POLY WIRES, ROPE & TAPES: Electrical Resistance Chart**

<b>Wire/Cable</b>	<b>Resistance (Ohms/Km)</b>	<b>Application</b>
Poly Wire Ecostop SS3	13300	Ideal for small temporary enclosures
Poly Wire Vario SS6	4000	Small and short fences – flexible & durable
Poly Wire Blue MIX3	380	Small to medium size fences
Poly Wire Blue MIX6	190	Medium to larger size fences
Poly Rope White MIX6	190	Larger fencing systems
Poly Tape MIX 12mm	180	High visibility blue
Poly Tape MIX 40mm	160	Wide high visibility for horses

---

## 4.8 Game fencing – permanent installation

Traditionally electric fence energizers for animal farming control did not have a fence monitor to detect a break in the fence.

The detecting feature has become an integral part of game and animal control. It allows the user to monitor the condition of the fence at the energizer without having to patrol the fence regularly, thus saving time and money. Poaching of game is an additional problem faced by game reserves and game farms, but the security features offered by the Nemtek electric fencing energizers can assist in this battle.

Fig 4.9: 2.4m fence system for elephant, leopard, rhino, lion, buffalo, wild pig & giraffe.

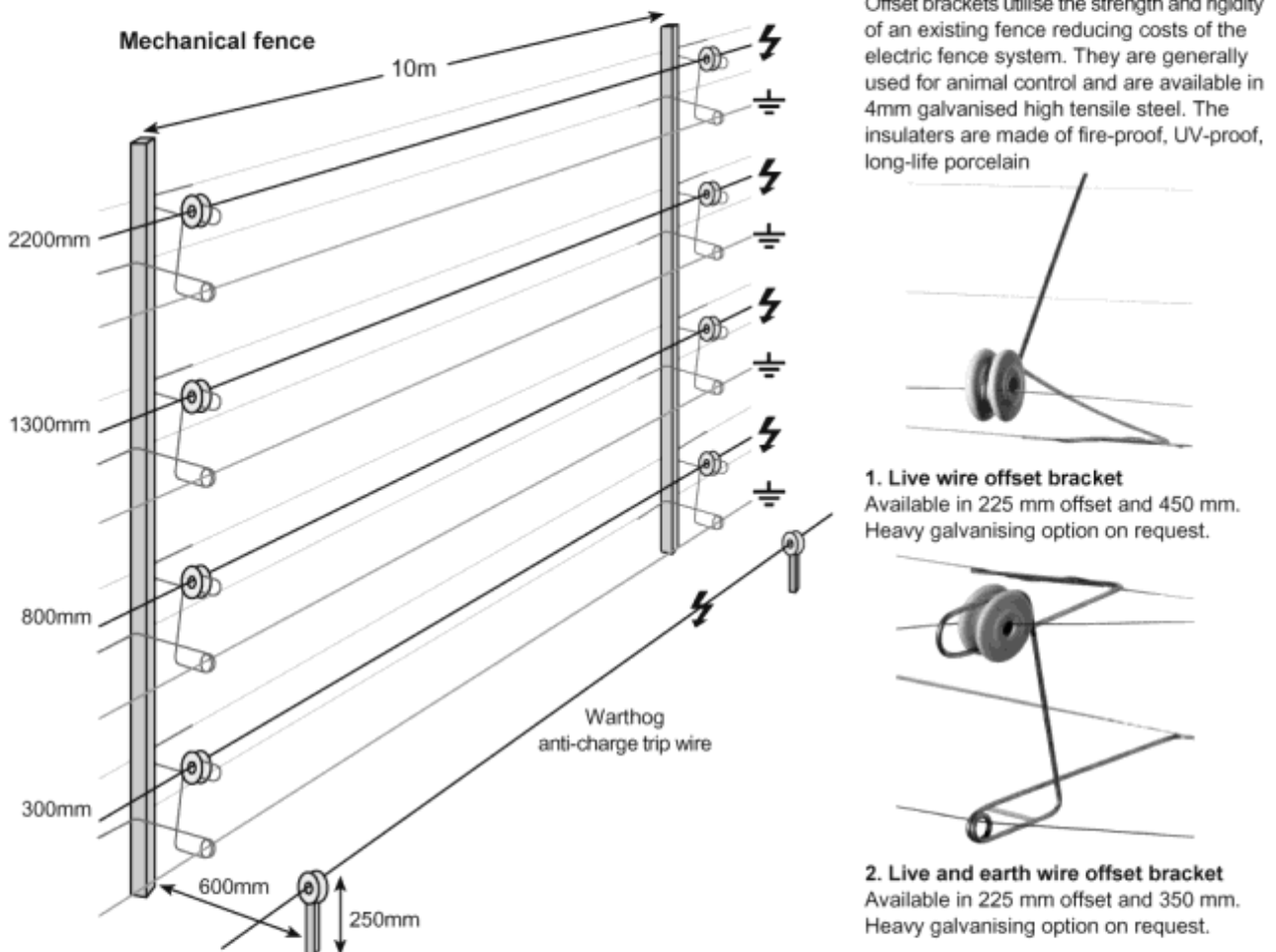

Double offsets (as in Fig 4.9) are primarily used where earthing conditions are poor. In year-round good earthing environments the double offsets can be replaced, or partially replaced by single offsets.

# NEMTEK

## Game fencing – river crossing

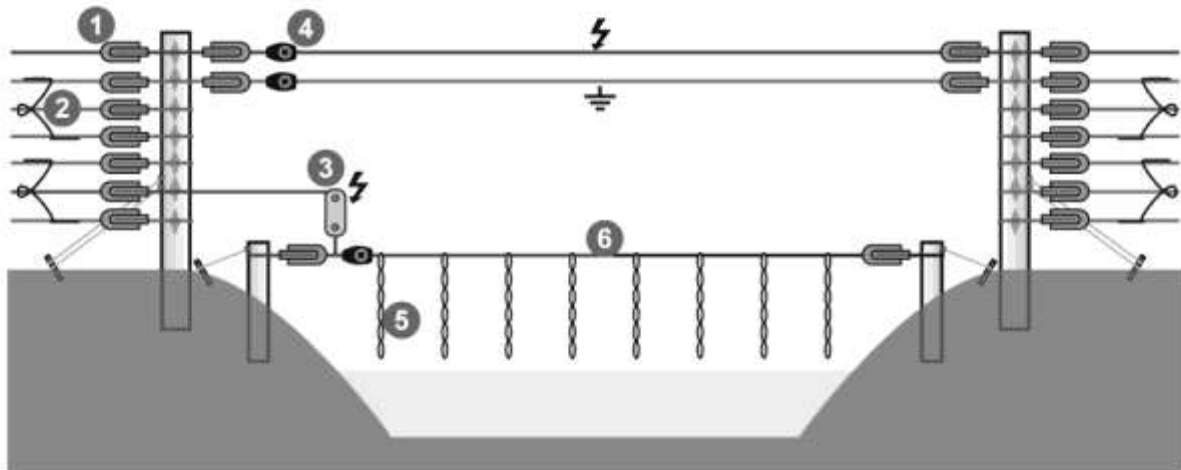

1. End strain
2. Offset brackets
3. Energy limiter / floodgate controller
4. Wire tensioner
5. Chains
6. Heavy cable to support the chains

The river flows and levels will vary depending on the seasons. As the water touches the chain the energy limiting floodgate controller will not allow the rest of the fence to short out. During very heavy flooding that section of fence can also be sacrificed without damage to the rest

# NEMTEK

## Game fencing – housing the energizer

Most energizers will be located far away from populated areas and a shock box installation will secure the energizer, battery, regulator and solar panel.

1. Solar panel
2. Shock box made from steel / aluminium
3. Nemtek energizer
4. Voltage regulator to control the voltage from solar power and to the battery
5. Deep cycle battery
6. On / off key switch, isolated from the shock box
7. Insulators to isolate the metal stand from the shock box
8. Metal stand

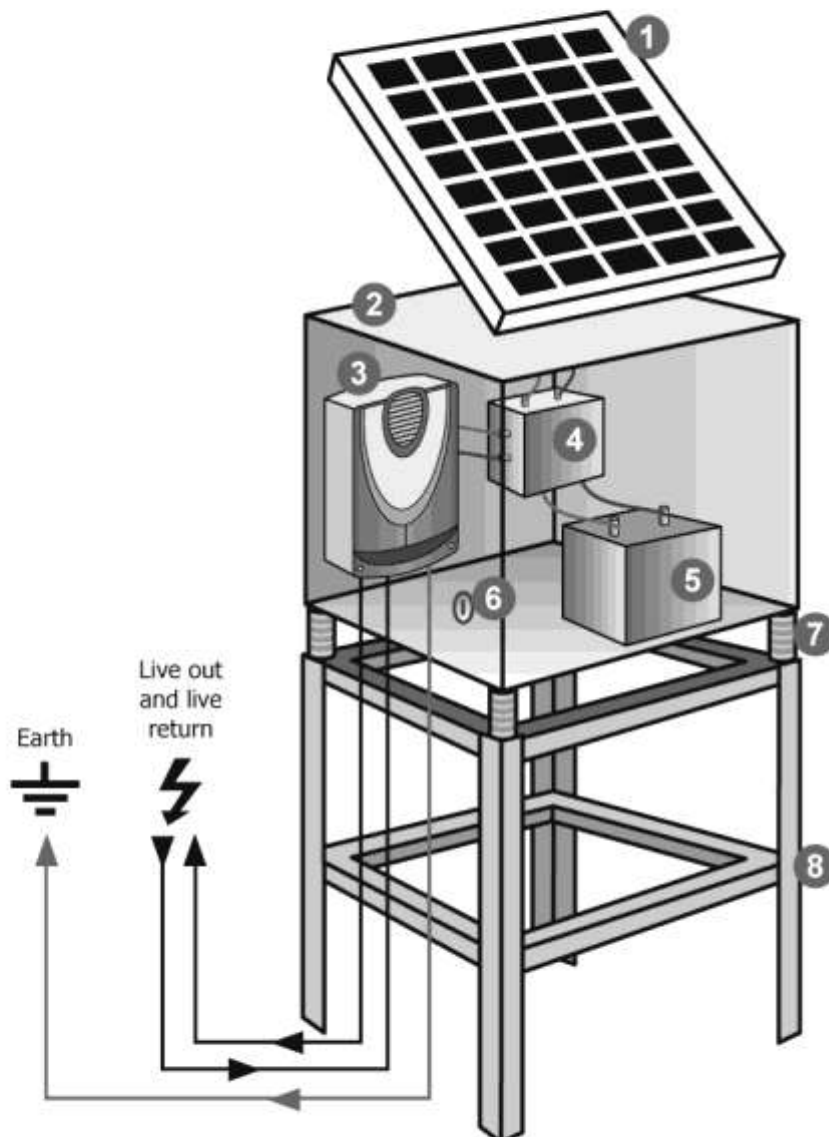

## 4.9 General information

### Tensioning of wire

In permanent fencing systems different products can be used to tension wire. Place the wire tensioner on both ends of the fence on long runs.



Porcelain tensioner



Earth tensioners



Nylon tensioner

### Joining wires – line clamps

Line clamps are used to join large diameter wires. They are galvanised to increase their lifespan.

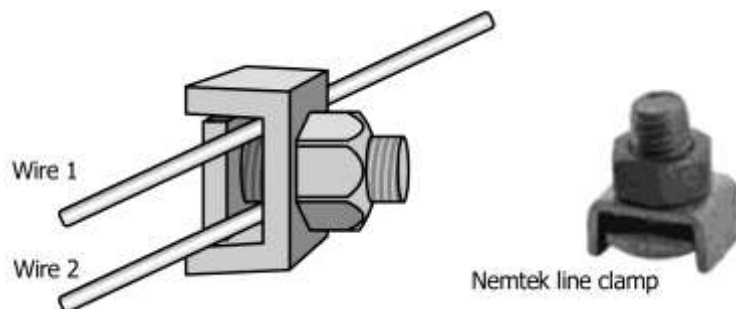

Nemtek line clamp

### Joining wires – ferrules

Ferrules can be used with smaller diameter wires and poly wires. They offer a permanent joint and are available in aluminium, stainless steel and tinned copper.

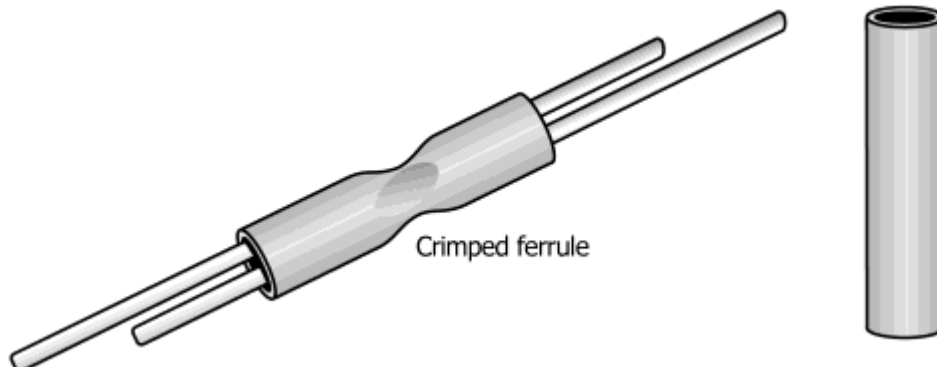

Crimped ferrule

# NEMTEK

## Gates

Electrifying gates using a gate handle and spring system makes the electric fencing highly visible and effective. The spring can stretch across the opening, diverting the animal away. Install under-gate cable under the gate to power up any sections on the opposite side.

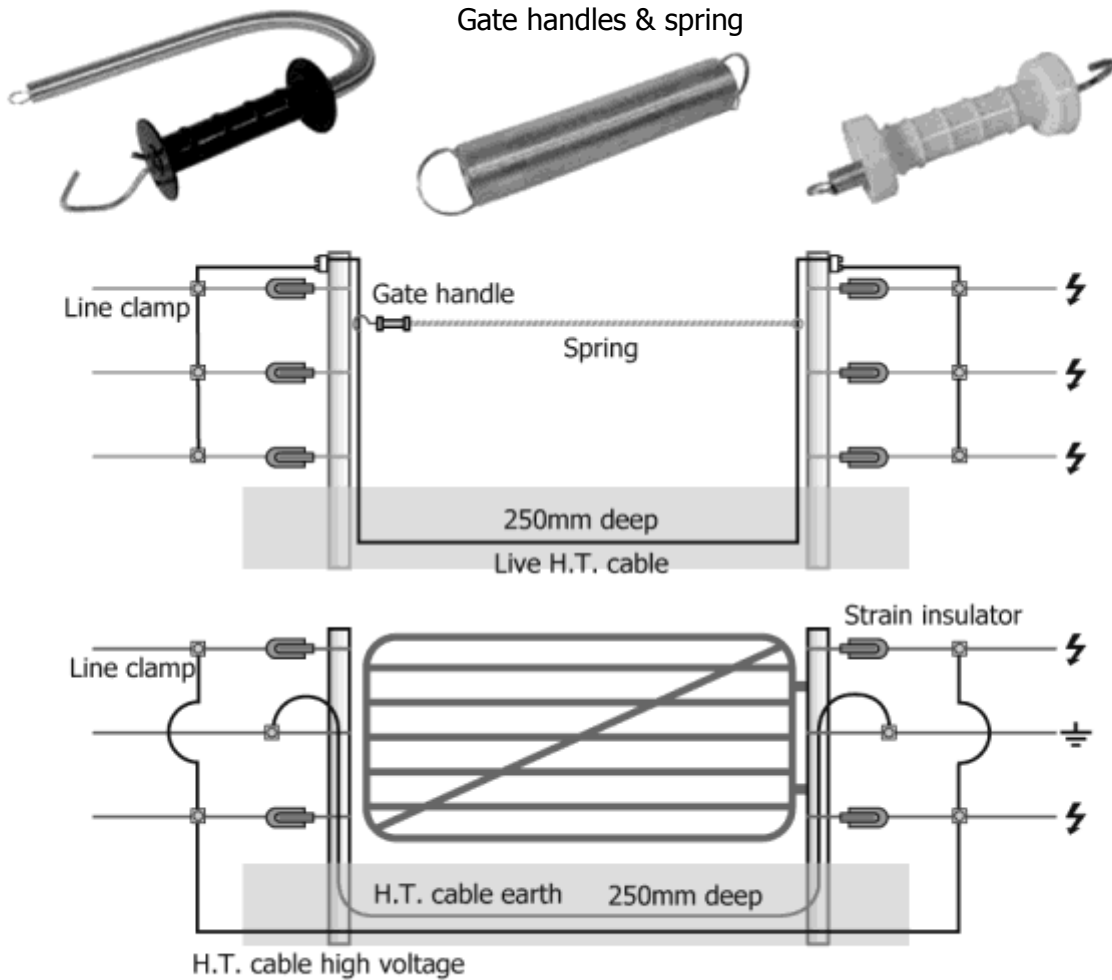

## Cut out switches

Cut out switches can be used to isolate sections of the fence. They are useful when fault finding as you can separate the fence into manageable sections, especially when the fence system is very large. This is particularly effective when applied to game fencing systems.



### 5. INSTALLATION OF A TEMPORARY/PORTABLE ELECTRIC FENCE

Temporary/portable fence systems tend to be made up of smaller runs than you would use in permanent fence systems.

Smaller energizers which rely on battery or solar power systems, are used to power up the fences (see Fig. 4.3 on page 15 energizers that operate on batteries).

There are many fence options available to control most animals

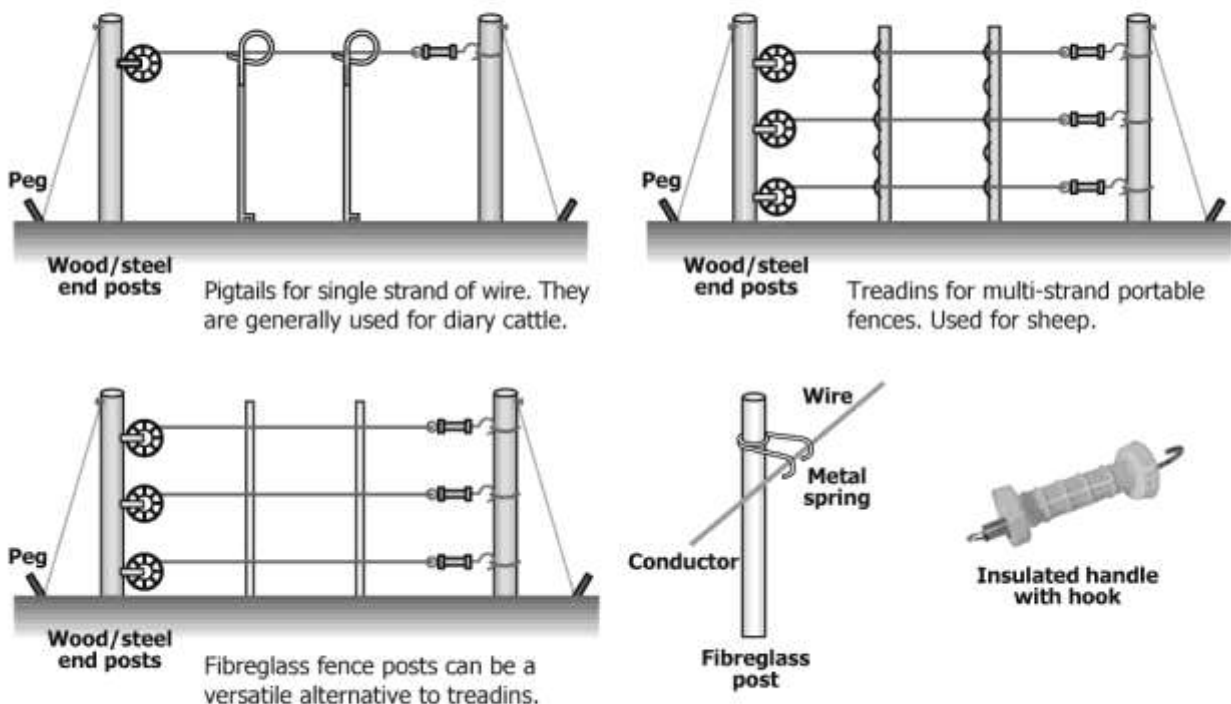

The end posts, usually made of wood or steel, need to be secured in order to carry the tension of the fence. A tensioning wire can assist in securing these posts (similar to a fence system).

The reels are used to collect the wire (poly wire, poly rope, poly tape) so that it can be used again.

Gate handles at the opposite end assist with hooking the wire to the end posts.

Poly wires, poly rope and poly tapes are used for the fence line due to their high visibility compared to normal wire. They can also be wound up onto the reels and reused.

### 6. FAULT FINDING

#### 6.1 Nemtek FenceScope™ Multitool

FenceScope is Nemtek's voltmeter (see Figure 6.2 on page 33), current meter and fault-finder in one. It saves hours checking fence lines for faults.

The FenceScope can be used for routine checking and maintenance of an electric fence. Typically indicating fence voltage, current amplitude and direction, and pulse repetition rate. It can give an audible indication, with pitch proportional to fence voltage, that is useful under lighting conditions or awkward locations

#### 6.2 Troubleshooting

Monitor the fence voltage using a FenceScope in voltage mode.

**If your fence has less than the recommended 3000V (3kV) minimum, check that:**

1. The energizer earth is O.K.
2. The energizer is powerful enough.
3. There are no shorts on the fence line.
4. The fence is correctly constructed.
5. Vegetation growth is not causing power loss.
6. The leadout wire is adequate.

To trace a fault using the FenceScope, travel along the fence line and check the voltage about every 100m. If the short is serious, the voltage will continue to fall until the fault is reached. If the fault is passed the voltage will remain fairly constant. You should then backtrack to find it. At fence junctions isolate different fences with a Cut Out Switch. Progress as above. If the current reading drops significantly the fault is back towards your previous reading. The process is similar to finding water leaks, where the FenceScope is reporting the amount and direction of the flow.



## 6.3 Fence fault finding chart

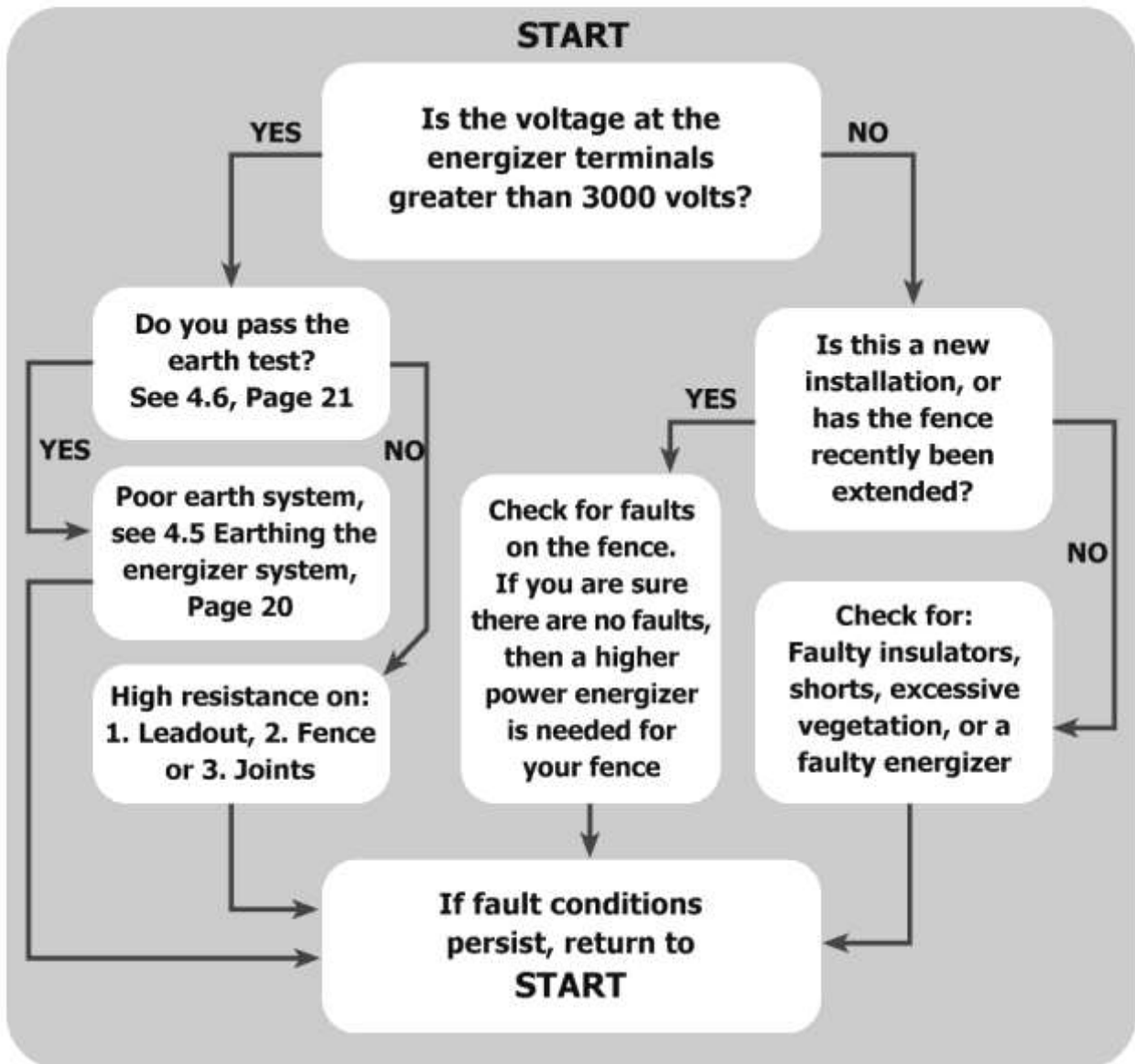

Fig 6.2



### 7. SAFETY REQUIREMENTS AND INTERFERENCE

Please read the manual that comes with your energizer before installing the unit and investigate the requirements of your local authority as they may vary from area to area.

Every effort is made by Nemtek to comply with the International standards for safety and interference, but they can vary from area to area.

Problems with interference generally arise due to installation shortfalls and this can create radio interference.

To assist in avoiding radio and telephone interference:

- The earth system on the fence must be at least 10m away from any other electrical earth system.
- Arcing on the fence will cause radio interference so vegetation and other causes of arcing must be removed and maintained.
- The high voltage lines must be far away from communication lines such as intercoms and telephones to reduce induced voltage to those lines.
- All High Tension cables that are installed underground must be far away from any other cables and not run in parallel for long distances. They must cross over at a 90 degree angle if required.
- Your insulators need to be of good quality and they need to be maintained and replaced when necessary to reduce arcing.
- Wire joins must be good. Use line clamps or ferrules, which are crimped.
- The mains earthing system needs to be in good working order.

#### Warning sign



Electric fence warning signs need to be placed every 100m along the fence in rural areas but every 10m in secure areas. This can vary from one local authority to another. All thoroughfares and changes in the direction of a fence need signs.

There may be other requirements for compliance in different areas and they need to be investigated and understood prior to erecting an electric fence system.

**8. Glossary**

---

<b>Term</b>	<b>Definition</b>
<b>AC -</b>	See "Alternating Current"
<b>Alternating Current -</b>	An electric current that reverses direction at regular intervals, having a magnitude that varies continuously in a sinusoidal manner
<b>Arc -</b>	A discharge of electricity through air or a gas.
<b>Ampere -</b>	The unit expressing the rate of flow of an electric current.
<b>Breakdown Voltage -</b>	The voltage at which a dielectric material fails.
<b>Circuit -</b>	A conductive path over which an electric charge may flow.
<b>DC -</b>	See "Direct Current".
<b>Direct Current -</b>	Electric current in which electrons flow in one direction only. Opposite of alternating current.
<b>Electricity -</b>	The flow of electrons through a conducting medium.
<b>Electrical Safety -</b>	Recognizing hazards associated with the use of electrical energy and taking precautions so that hazards do not cause injury or death.
<b>Induced Voltage -</b>	A voltage produced around a closed path or circuit by a change of magnetic flux linking that path.
<b>Insulator -</b>	A device that is used to electrically isolate a conductor or electrical device from ground or a different electrical potential.
<b>Joule Output -</b>	One Joule is one Watt per second. It's the measure of units of energy. Stored Joules is only a theoretical element without practical significance.
<b>Ohm -</b>	A unit of electrical resistance defined as the resistance of a circuit with a voltage of one volt and a current flow of one ampere.

# NEMTEK

<b>Term</b>	<b>Definition</b>
<b>Ohm's Law -</b>	$E=IR$ ; $I=E/R$ ; $R=E/I$ ; Where E = Voltage impressed on a circuit, I = current flowing in a circuit and R = circuit resistance. Ohm's Law is used for calculating voltage drop, fault current and other characteristics of an electrical circuit
<b>Regulator -</b>	A device that is used to control the voltage of a circuit by raising and lowering it.
<b>Resistance -</b>	The opposition to current flow, expressed in ohms.
<b>Short Circuit -</b>	A load that occurs when a conductor comes into contact with another conductor or grounded object. An abnormal connection of relatively low impedance between two points of different potentials
<b>Tensile Strength -</b>	The greatest longitudinal force that a substance can bear without tearing apart or rupturing; also called ultimate tensile strength.
<b>Volt -</b>	A unit of electromotive force. The electrical potential needed to produce one ampere of current with a resistance of one ohm.

**9. NOTICES REGARDING THE USE OF THE INFORMATION  
WITHIN THIS MANUAL**

In no event shall Nemtek and/or its respective suppliers be liable for any special, indirect or consequential damages or any damages whatsoever, howsoever arising including but not limited to damages resulting from personal injury, damage to property or loss of profits, whether in an action of contract, negligence or other tortious action, arising out of or in connection with the use of the information within this manual.